



TENHOLD™

TSP

**TAILORED SOLUTIONS PROVIDER
GUIDE**

www.tenhold.com



THE ULTIMATE PUSH BUMPER FOR **YOUR FLEET**

The Tenhold™ push bumper, engineered specifically for law enforcement vehicles provides unmatched durability, sleek styling and modular functionality.



WING

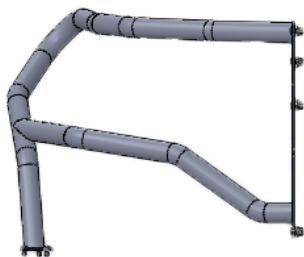

PIT/TVI BAR

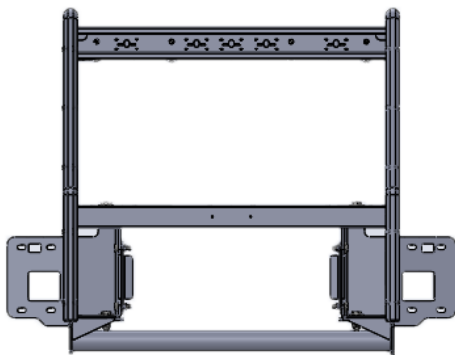

PUSH BUMPER



EASY INSTALLATION

Mounting tabs built for a quick, simple install – saving costly install turnaround.

BUILT TOUGH TO PERFORM

Heavy duty build delivers superior durability and ensures the safety of the officer and civilian during pursuits.



CLEAR VISIBILITY FOR OFFICERS

The bumper's height makes the point of contact easy to identify from the driver's seat, improving consistency and confidence during pursuits.

CUSTOM LIGHT PLACEMENT

Flippable bracket adapts to multiple light bar brands for perfect placement.





CONTOUR CONSOLES

Tenhold™ Contour Consoles are designed around the vehicle, built to meet real agency needs, and unmatched in performance, our consoles deliver seamless integration, dependable durability, and the confidence that no competitor can match.





MAX DEPTH CONTOUR CONSOLE

The Tenhold™ Max Depth Contour Console provides increased mounting depth and optimized space for high-density equipment installs, allowing secure, organized integration of radios, controls, and electronics without sacrificing ergonomics or accessibility.

IPB (INTEGRATED PRINTEK/BROTHER) CONTOUR CONSOLE

Tenhold™ was the first to design the Integrated Printek/Brother holder into a console. The IPB Contour Console integrates a PrintekMobile I80 or Brother PJ6/7/8 printer with easy-access paper storage.



DGS (DUTY GEAR SAVER) CONTOUR CONSOLE

The Duty Gear Saver Contour Console uses a dash-contoured design to support communication and lighting equipment while providing added clearance for a duty belt and sidearm.



THE MAMBA MOUNT

Simplify your on-duty experience with the Mamba Mount, a console side mount designed to work however you do.



PARK & WORK



STORE & DRIVE



TACTICALLY SAFE



**NEW MOUNT
COMING 2026**





CONSOLE SIDE MOUNT

The Tenhold™ Console Side Mount mounts to the passenger side of a compatible console without drilling into the vehicle, and maintaining legroom. The straight arm supports secure, comfortable laptop use with the A-MOD or other desktops.





A-MOD DESKTOP

ADJUSTABLE-MOBILE OPERATIONS DESKTOP



The A-MOD is designed to securely hold laptops in demanding environments. It features a lightweight, rugged construction using high-strength aluminum, composite materials, and steel. A solid brass tubular lock and case-hardened steel side and rear clamps provide reliable security and retention.

MOUNTING STATIONS

Works with:

- Tenhold™ No Holes Mount
- Tenhold™ HD No Holes Mount

Made for:

- Apple iPad (Gen 1, 2, 3, and Pro)
- Panasonic Toughpad FZ-G1
- Microsoft Surface Pro
- HP Elite X2 ...and more!





NO HOLES MOUNT

Field-proven over the past 20 years, Tenhold™ offers mobile professionals the best laptop mount for cars, trucks, vans, and SUVs.

- Quick and easy installation
- Multi-point articulating arm
- Height adjustable stand
- 360° rotating laptop tray
- Ergonomically designed to reduce back strain
- Work from the driver or passenger seat
- Stores away while driving
- Easily customized



HEAVY DUTY NO HOLES MOUNT

- Upgraded HD Base
- Upgraded HD Stand
- Upgraded HD Arm





WEAPON MOUNTING SOLUTIONS

Our weapon mounting solutions are built to adapt to virtually any configuration. Whether you need single or dual weapon setups, they can be mounted to partitions, single cells, rear seats, the rear hatch, or even free-standing structures.



PARTITION MOUNT

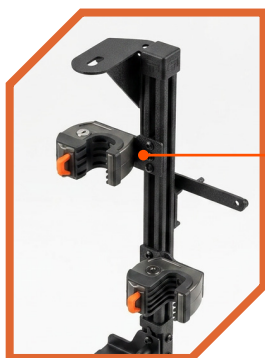

Now offering the suppressor ready lockhead

- Tamper proof (magnet or hot-wiring)
- Zinc lock head design deforms instead of breaking
- Silicone inserts in lock head protect weapon from damage
- Quickly adjust AR side along the strong extruded backbone to accommodate various stocks
- Single or dual weapon
- Plug and play lock head/timer wiring
- Compact size - 1/3 smaller than other lock heads
- Innovative slide latch recesses inside housing when accessing firearm

SMARTLOCK TECHNOLOGY

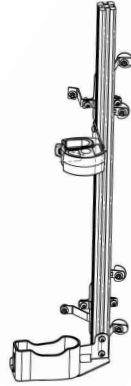
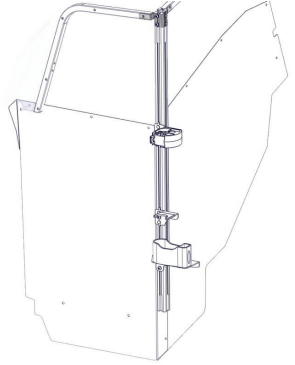

U.S. Patent No. 8,910,560 and U.S. Patent No. 10,563,943

TENHOLD



SPACE CREATOR VEHICLE PARTITIONS

Tenhold™ pioneered the Space Creator Partition, featuring a bidirectional recessed housing that creates additional legroom behind the front passenger seat. This design maximizes usable space to accommodate larger prisoners while maintaining full comfort and positioning for the officer. It also preserves room for a console, gun rack, and printer. The partition mounts to OEM points for a universal fit with no vehicle modifications required.





WITH HIGH SECURITY/HIGH VISIBILITY WINDOW

High-security partition engineered with a high-visibility window—providing up to 40% more visibility than competitors.

UNIDIRECTIONAL RECESSED HOUSING VEHICLE PARTITIONS



HIGH SECURITY EXTENSION PANEL

Enhance partition security by preventing rear passengers from kicking contraband under front seats with a two-piece, steel High Security Extension Panel.





REPLACEMENT BIO-SEAT SYSTEM

- Improves officer safety
- Immediate upper body restriction
- Simple and effective design
- Belt storage position - increases ease of use
- Extremely durable
- Quick and easy clean ups
- Efficient installation
- Designed with OEM CAD - making contraband easy to spot and hard to hide
- Door side buckle system lessens prisoner contact and increased use of seat belts





WINDOW ARMOR & DOOR PANELS

You need to protect your vehicles while transporting prisoners. The Tenhold™ line of window armor and door panels is easy to install and easy to clean. All Tenhold™ window armor and door panels are design to perfectly fit your service vehicle.





SINGLE CELL

- Creates a cocoon-like cell that allows for the complete and safe enclosure of a prisoner.
- Eliminates the prisoner's ability to lie down and kick out windows or damage doors.
- Maintain 100% travel & recline ability of drivers' seat, allows taller officers to finally fit in their office.
- In a crash, the driver's seat will perform as designed by the vehicle manufacturer.
- Allows for storage behind driver seat. Keep rain gear, campaign hat, files, printer, and duty gear better stowed away.





SINGLE CELL LITE



CARGO BARRIERS

Separate prisoner and rear cargo areas securely with the Tenhold™ line of Cargo Barriers. Keep prisoners in their area in case of a crash and keep cargo where it belongs. Designed to secure behind the second row of seats in a SUV, Tenhold™ Cargo Barriers utilize OEM mounting points, install quickly, and require no vehicle modifications.



CB4 WITH POLY COVER



CB4



A CARGO BOX THAT'S READY FOR DUTY

The Tenhold™ Cargo Box is the secure, smart storage solution for today's law enforcement vehicles.

- Rugged storage
- Secure gear
- Eliminate clutter
- Streamline upfitting



TOP RAIL

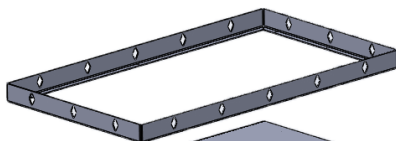

CARGO BOX
with or without
slam lock

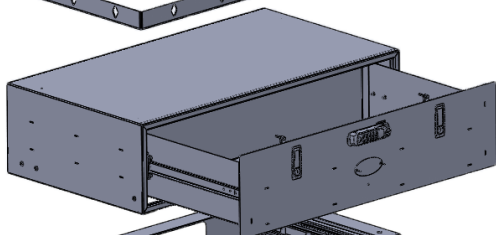

**EQUIPMENT
TRAY**

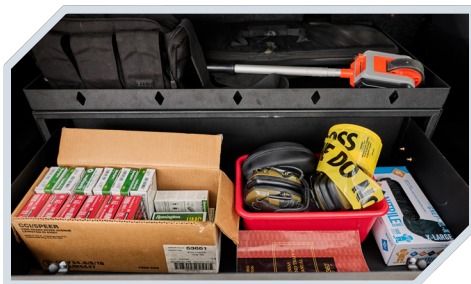
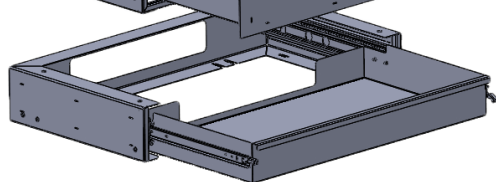

KEEPS YOUR GEAR SAFE

Our advanced locking system with an electronic keypad prevents theft.



RUGGED, YET LIGHTWEIGHT

Built tough for the field without weighing you down.



EASY INSTALLATION

Our universal design allows for quick setup with minimal vehicle modifications and keeps vehicles in service longer.



FULLY CUSTOMIZABLE

Optional equipment tray and top rail adds layered storage, making it easier to separate and access mission critical gear.

DEFEND IR

You take every available precaution to secure your vehicle. Unfortunately, criminals also make every effort to bypass these precautions.

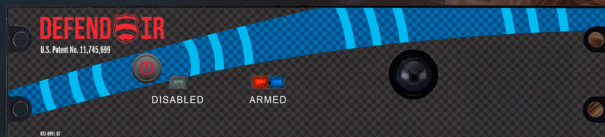

Defend IR Security System from Tenhold™ is the first solution designed specifically to help prevent patrol vehicle break-ins. When armed, it monitors the vehicle interior using an infrared sensor. If motion is detected, it activates the vehicle's lights and siren – alerting those nearby and helping deter theft.



U.S. Patent No. 11,745,699

405 W. EASY ST., ROGERS, AR 72756 • TENHOLD.COM • 6/26

Tenhold™, a division of Kiefer Sage™. Specifications subject to change without notice.